

**2L-CONVEX POLYOMINOES: GEOMETRICAL ASPECTS**

KHALIL TAWBE AND LAURENT VUILLON

ABSTRACT. A polyomino P is called $2L$ -convex if for every two cells there exists a monotone path included in P with at most two changes of direction. This paper studies the geometrical aspects of a sub-class of $2L$ -convex polyominoes called $\mathfrak{S}_{2L}^{0,0}$ and states a characterization of it in terms of monotone paths. In a second part, four geometries are introduced and the tomographical point of view is investigated using the switching components (that is, the elements of this sub-class that have the same projections). Finally, some unicity results are given for the reconstruction of these polyominoes according to their projections.

1. INTRODUCTION

There are many notions of discrete convexity of polyominoes (namely HV -convex [1], Q -convex [2], L -convex polyominoes [5]) and each one leads to interesting studies. One natural notion of convexity on the discrete plane is the class of HV -convex polyominoes that is polyominoes with consecutive cells in rows and columns. Following the works of Del Lungo, Nivat, Barcucci, and Pinzani [1] we are able using discrete tomography to reconstruct polyominoes that are HV -convex according to their horizontal and vertical projections. In addition to that, for an HV -convex polyomino P every pair of cells of P can be reached using a path included in P with only two kinds of unit steps (such a path is called monotone). A polyomino is called kL -convex if for every two cells we find a monotone path with at most k changes of direction. Obviously a kL -convex polyomino is an HV -convex polyomino. Thus, the set of kL -convex polyominoes for $k \in \mathbb{N}$ forms a hierarchy of HV -convex polyominoes according to the number of changes of direction of monotone paths. This notion of L -convex polyominoes has been introduced by Castiglione and Restivo [4] and their geometrical structure and tomographical reconstruction are well known. In fact $2L$ -convex polyominoes are more geometrically complex and there is no result for their direct reconstruction. We could notice that Duchi, Rinaldi, and Del Lungo are able to enumerate this class in an interesting and technical article [8].

Received by the editors April 2, 2009, and in revised form May 5, 2010.

2000 *Mathematics Subject Classification.* (Missing.)

Key words and phrases. Discrete geometry, convex polyominoes, discrete tomography.

But the enumeration technique gives no idea for the tomographical reconstruction. In this paper, we study the geometrical aspects of a sub-class of $2L$ -convex polyominoes called $\mathfrak{S}_{2L}^{0,0}$ and we state a characterization of it in terms of monotone paths. In a second part, we introduce 4 geometries of this sub-class and we investigate the switching components (that is the elements of this sub-class that have the same projections) and we give also some unicity results.

This paper is divided into 6 sections. After basics on polyominoes, Section 3 gives the geometrical properties and the characterization of a sub-class of $2L$ -convex polyominoes. In Section 4, the possible configurations of polyominoes in the class $\mathfrak{S}_{2L}^{0,0}$ are investigated using switching components made of 1-cycle or 2-cycles. We also focus on the unicity results for this class of polyominoes. All the cases are summarized in a table at the end of this section. Section 5 has a look to directed sets of $2L$ convex polyominoes. The last section is about the final comments.

2. DEFINITION AND NOTATION

A planar discrete set is a finite subset of the integer lattice \mathbb{N}^2 defined up to translation. A discrete set can be represented either by a set of cells, i.e. unitary squares of the cartesian plane, or by a binary matrix, where the 1's determine the cells of the set (see Figure 1).

A polyomino P is a finite connected set of adjacent cells, defined up to translation, in the cartesian plane. A polyomino is said to be *column-convex* (resp. *row-convex*) if every column (resp. row) is connected (see [7, 9]). Finally, a polyomino is said to be *convex* (or *HV-convex*) if it is both column and row-convex (see Figure 2).

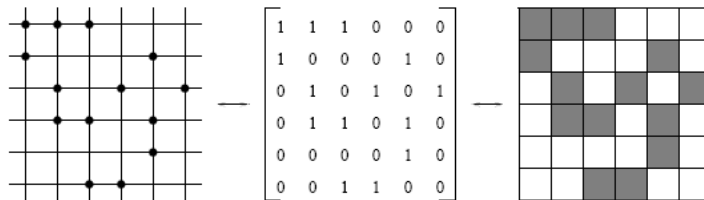

FIGURE 1. A finite set of $\mathbb{N} \times \mathbb{N}$, and its representation in terms of a binary matrix and a set of cells. (The origin of the this figure is in [3]).

To each discrete set S , represented as a $m \times n$ binary matrix, we associate two integer vectors $H = (h_1, \dots, h_m)$ and $V = (v_1, \dots, v_n)$ such that for each $1 \leq i \leq m$, $1 \leq j \leq n$, h_i and v_j are the number of cells of S (elements 1 of the matrix) which lie on row i and column j , respectively. The vectors H and V are called the $2L$ -convex Tawbevuillon *horizontal* and *vertical* projections of S , respectively (see Figure 3). By convention, the origine

of the matrix (that is the cell with coordinates $(1, 1)$) is in the upper left position.

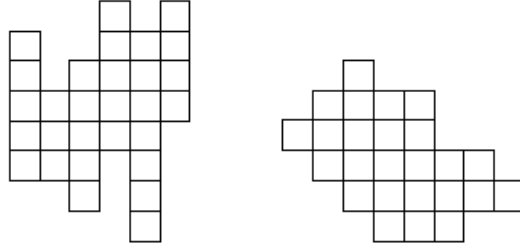

FIGURE 2. A column convex (left) and a convex (right) polyomino. (The origin of this figure is in [5]).

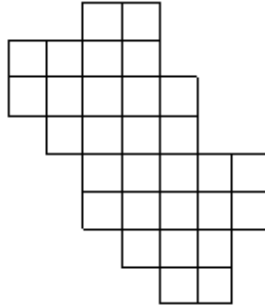

FIGURE 3. A polyomino P with $H = (2, 4, 5, 4, 5, 5, 3, 2)$ and $V = (2, 3, 6, 7, 6, 4, 2)$.

For any two cells A and B in a polyomino P , a *path* \prod_{AB} , from A to B, is a sequence $(i_1, j_1), (i_2, j_2), \dots, (i_r, j_r)$ of adjacent disjoint cells of P , with $A = (i_1, j_1)$, and $B = (i_r, j_r)$. For each $1 \leq k \leq r - 1$, we say that the two consecutive cells $(i_k, j_k), (i_{k+1}, j_{k+1})$ form:

- an *east* step if $i_{k+1} = i_k$ and $j_{k+1} = j_k + 1$;
- a *north* step if $i_{k+1} = i_k - 1$ and $j_{k+1} = j_k$;
- a *west* step if $i_{k+1} = i_k$ and $j_{k+1} = j_k - 1$; and
- a *south* step if $i_{k+1} = i_k + 1$ and $j_{k+1} = j_k$.

Finally, we define a path to be *monotone* if it is entirely made of only two of the four types of steps defined above.

Proposition 1 (Castiglione, Restivo [4]). *A polyomino P is convex if and only if every pair of cells is connected by a monotone path.*

Let us consider a polyomino P . A path in P has a change of direction in the cell (i_k, j_k) , for $2 \leq k \leq r - 1$, if

$$i_k \neq i_{k-1} \iff j_{k+1} \neq j_k.$$

Definition 1. A convex polyomino such that every pair of its cells can be connected by a monotone path with at most k changes of direction is called kL -convex.

In [4, 3], it is proposed a hierarchy on convex polyominoes based on the number of changes of direction in the paths connecting any two cells of the polyomino.

For $k = 1$, we have the first level of hierarchy, i.e. the class of 1-convex polyominoes, also denoted L-convex polyominoes for the typical shape of each path having at most one single change of direction. In the present studies we focus our attention to the next level of the hierarchy, i.e. the class of $2L$ -convex polyominoes, whose tomographical properties turn out to be more interesting and substantially harder to be investigated than those of L-convex polyominoes (see Figure 4).

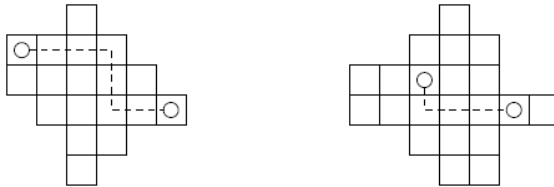

FIGURE 4. The convex polyomino on the left is $2L$ -convex, while the one on the right is L-convex. For each polyomino, two cells and a monotone path connecting them are shown. (The origin of this figure is in [3].)

3. GEOMETRICAL PROPERTIES OF $2L$ -CONVEX POLYOMINOES

In this section, we study the geometrical properties of $2L$ -convex polyominoes in terms of positions of the feet. Let (H, V) be two vectors of projections and let P be a convex polyomino, that satisfies (H, V) . By a classical argument P is contained in a rectangle R of size $m \times n$ (called minimal bounding box). Let $[\min(S), \max(S)]$ ($[\min(E), \max(E)]$, $[\min(N), \max(N)]$, $[\min(W), \max(W)]$) be the intersection of P 's boundary on the lower (right, upper, left) side of R (see [1]). By abuse of notation, for each $1 \leq i \leq m$ and $1 \leq j \leq n$, we call $\min(S)$ [resp. $\min(E)$, $\min(N)$, $\min(W)$] the cell at the position $(m, \min(S))$ [resp. $(\min(E), n)$, $(1, \min(N))$, $(\min(W), 1)$] and $\max(S)$ [resp. $\max(E)$, $\max(N)$, $\max(W)$] the cell at the position $(m, \max(S))$ [resp. $(\max(E), n)$, $(1, \max(N))$, $(\max(W), 1)$] (see Figure 5).

Definition 2. The segment $[\min(S), \max(S)]$ is called the *S-foot*. Similarly, the segments $[\min(E), \max(E)]$, $[\min(N), \max(N)]$ and $[\min(W), \max(W)]$ are called *E-foot*, *N-foot* and *W-foot*.

Definition 3. Let P be a convex polyomino, we say that P is *h-centered* [resp. *v-centered*], if its *W-foot* and *E-foot* [resp. *N-foot* and *S-foot*] intersect (see Figure 6), (they are defined in [6]).

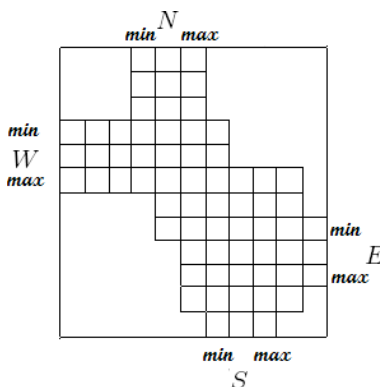

FIGURE 5. Min and max of the four feet in the rectangle R .

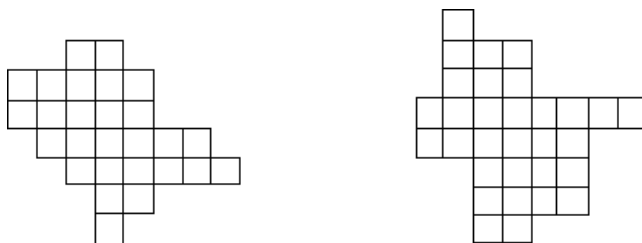

FIGURE 6. A *v-centered* polyomino on the left and an *h-centered* polyomino on the right.

The following property links *h-centered* and *v-centered* polyominoes to *2L-convex* polyominoes.

Proposition 2. If P is an *h-centered* polyomino or a *v-centered* polyomino, then it is a *2L-convex* polyomino.

Proof. Let us assume that P is *h-centered*, the *W-foot* and the *E-foot* intersect in a row i . The row i is used to go from any point of P to any other point of P . Thus there is at most two changes of direction. That is P is a *2L-convex* polyomino. If P is *v-centered* a similar reasoning holds. \square

From now on, we suppose that P is not *h-centered*, *v-centered* and *L-convex* polyomino. Let \mathcal{C} be the class of convex polyominoes, thus we have

four classes of polyominoes regarding the position of the non-intersecting feet.

$$\begin{aligned}\mathfrak{S} &= \{P \in \mathcal{C} \mid \max(N) < \min(S) \text{ and } \max(W) < \min(E)\}, \\ \mathfrak{S}' &= \{P \in \mathcal{C} \mid \max(S) < \min(N) \text{ and } \max(E) < \min(W)\}, \\ \gamma &= \{P \in \mathcal{C} \mid \max(N) < \min(S) \text{ and } \max(E) < \min(W)\}, \\ \gamma' &= \{P \in \mathcal{C} \mid \max(S) < \min(N) \text{ and } \max(W) < \min(E)\}.\end{aligned}$$

Let us define the horizontal transformation (symmetry)

$$S_H : (i, j) \longrightarrow (m - i + 1, j)$$

which transforms the polyomino P from the class \mathfrak{S} to the class \mathfrak{S}' . Note that S_H maps \mathfrak{S} to \mathfrak{S}' and γ to γ' and obviously by involution \mathfrak{S}' to \mathfrak{S} and γ' to γ . Indeed the transformation acts on the feet of the polyomino as it is shown in the following table (see Figure 7). Thus we only give the proofs of the classes \mathfrak{S} and γ .

N, S		W, E	
S	$\longrightarrow N$	W	$\longrightarrow W$
N	$\longrightarrow S$	E	$\longrightarrow E$
		\leq	$\iff \geq$
min	\longrightarrow min	min	\longrightarrow max
max	\longrightarrow max	max	\longrightarrow min

FIGURE 7. The horizontal transformation S_H on the feet of P .

The classes γ and γ' lead to $2L$ -convex polyominoes.

Proposition 3. *If P is a convex polyomino in γ , then it is a $2L$ -convex polyomino.*

Proof. By convexity, there exists an L -path between $\min(W)$ and $\min(N)$, an L -path between $\max(W)$ and $\min(S)$, an L -path between $\max(S)$ and $\max(E)$ and, an L -path between $\min(E)$ and $\max(N)$. One can deduce that any two points belonging to P can be connected by a path having at most two changes of direction, hence P is $2L$ -convex polyomino (see Figure 8). \square

Proposition 4. *If P is a convex polyomino in γ' , then it is a $2L$ -convex polyomino (see Figure 9).*

Proof. Same arguments as of the class γ up to the symmetry S_H . \square

The study of the classes \mathfrak{S} and \mathfrak{S}' is more difficult and technical. We make the choice of studying a special case called $\mathfrak{S}^{0,0}$ where the upper left corner and the lower right corner of the polyomino is empty. For this case, we introduce 4 geometries in order to describe the geometries of $2L$ -convex polyominoes in the class $\mathfrak{S}^{0,0}$ and to give characterizations of such $2L$ -convex polyominoes in terms of paths.

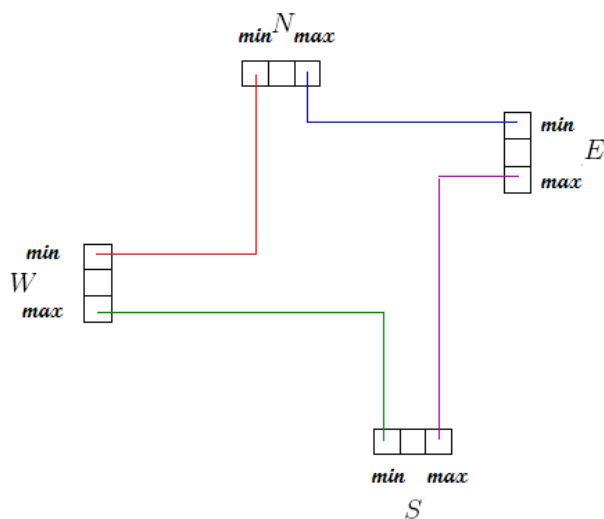

FIGURE 8. L's between the feet.

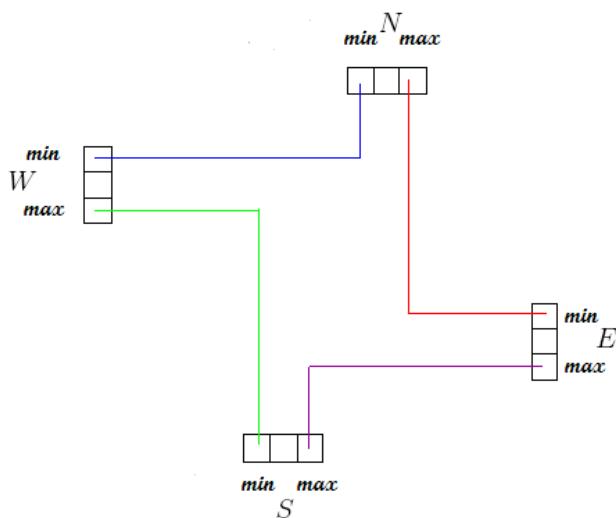

FIGURE 9. L's between the feet.

For a bounding rectangle R and for a given polyomino P , let us define the following sets

$$\begin{aligned}
 WN &= \{(i, j) \in P \mid i < \min(W) \text{ and } j < \min(N)\}, \\
 SE &= \{(i, j) \in P \mid i > \max(E) \text{ and } j > \max(S)\}, \\
 NE &= \{(i, j) \in P \mid i < \min(E) \text{ and } j > \max(N)\}, \\
 WS &= \{(i, j) \in P \mid i > \max(W) \text{ and } j < \min(S)\}.
 \end{aligned}$$

The above sets with the classes \mathfrak{S} and \mathfrak{S}' allow us to define the following four classes:

$$\begin{aligned} \mathfrak{S}^{0,0} &= \left\{ P \in \mathcal{C} \mid \begin{array}{l} \text{card}(WN) = 0 \text{ and } \text{card}(SE) = 0, \\ \max(W) < \min(E) \text{ and } \max(N) < \min(S) \end{array} \right\}, \\ \mathfrak{S}'^{0,0} &= \left\{ P \in \mathcal{C} \mid \begin{array}{l} \text{card}(NE) = 0 \text{ and } \text{card}(WS) = 0, \\ \max(S) < \min(N) \text{ and } \max(E) < \min(W) \end{array} \right\}, \\ \mathfrak{S}_{2L}^{0,0} &= \left\{ P \in \mathcal{C} \mid \begin{array}{l} \text{card}(WN) = 0 \text{ and } \text{card}(SE) = 0, \\ \max(W) < \min(E) \text{ and } \max(N) < \min(S) \end{array} \right\}, \\ \mathfrak{S}'_{2L}{}^{0,0} &= \left\{ P \in \mathcal{C} \mid \begin{array}{l} \text{card}(NE) = 0 \text{ and } \text{card}(WS) = 0, \\ \max(S) < \min(N) \text{ and } \max(E) < \min(W) \end{array} \right\}, \end{aligned}$$

where P is a $2L$ -convex polyomino (see Figure 10).

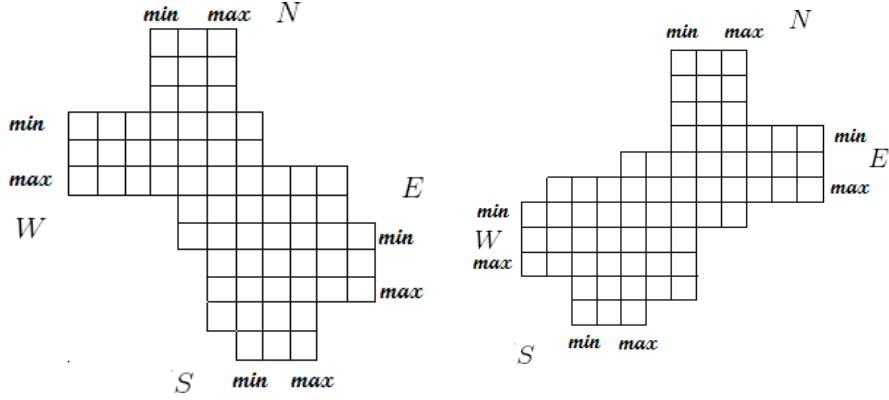

FIGURE 10. An element of the class $\mathfrak{S}_{2L}^{0,0}$ on the left and one of the class $\mathfrak{S}'_{2L}{}^{0,0}$ on the right.

Note that the horizontal symmetry S_H maps $\mathfrak{S}_{2L}^{0,0}$ to $\mathfrak{S}'_{2L}{}^{0,0}$. The following characterizations hold for convex polyominoes in the class $\mathfrak{S}^{0,0}$.

Theorem 1. *Let P be a convex polyomino in the class $\mathfrak{S}^{0,0}$, P is $2L$ -convex if and only if there exist four paths*

- (1) from $\min(N)$ to $\max(E)$,
- (2) from $\min(N)$ to $\max(S)$,
- (3) from $\min(W)$ to $\max(E)$, and
- (4) from $\min(W)$ to $\max(S)$.

having at most two changes of direction.

Proof.

(\implies) It is an immediate consequence of the definition of $2L$ -convex polyomino.

(\Leftarrow) Suppose that P is not $2L$ -convex, then there exist two points (i_0, j_0) , (i_1, j_1) such that any path between them has more than two changes of direction. The worst case occurs when the two points are situated on two distinct feet. We make the proof for the feet N and E (the other cases are similar). Assume that (i_0, j_0) is at the position $(1, \min(N) \leq j_0 \leq \max(N))$ and (i_1, j_1) is at the position $(\min(E) \leq i_1 \leq \max(E), n)$. We have the two following cases.

CASE 1:

If the path from $\min(N)$ to $\max(E)$ has one change of direction, i.e. there exists an L -path between them, then by convexity there is an L -path between (i_0, j_0) and (i_1, j_1) , hence the contradiction.

CASE 2:

If the path from $\min(N)$ to $\max(E)$ has two changes of direction, one can observe the following cases.

- Either the path goes through $\min(E)$ and then there exist an L -path between $\min(N)$ and $\min(E)$, thus by convexity there exists a $2L$ -path from (i_0, j_0) to (i_1, j_1) , hence the contradiction; or
- the path goes through $\max(N)$ and then there is an L -path between $\max(N)$ and $\max(E)$, thus there exists a $2L$ -path from (i_0, j_0) to (i_1, j_1) , hence the contradiction (see Figure 11).

The proofs for (2), (3), and (4) are similar up to symmetry. □

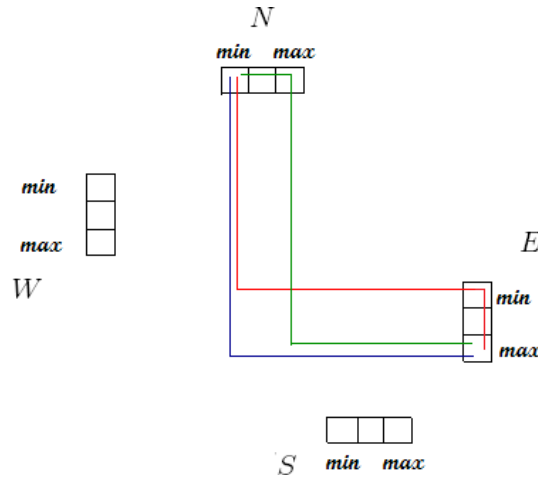

FIGURE 11. L -path and $2L$ -path between $\min(N)$ and $\max(E)$ through $\max(N)$ and $\min(E)$.

Corollary 1. *If P satisfies the conditions of Theorem 1, then P is in the class $\mathfrak{S}_{2L}^{0,0}$.*

Theorem 2. *Let P be a convex polyomino in the class $\mathfrak{S}^{0,0}$, P is $2L$ -convex if and only if there exists an L -path from*

$$(1) \quad \begin{cases} \max(N) \text{ to } \max(E) \\ \text{and} \\ \max(W) \text{ to } \max(S) \end{cases}$$

or

$$(2) \quad \begin{cases} \min(N) \text{ to } \min(E) \\ \text{and} \\ \min(W) \text{ to } \min(S) \end{cases}$$

or

$$(3) \quad \begin{cases} \min(N) \text{ to } \min(E) \text{ and } \max(W) \text{ to } \max(S) \\ \text{and} \\ 2L\text{-path from } \min(W) \text{ to } \max(E) \end{cases}$$

or

$$(4) \quad \begin{cases} \max(N) \text{ to } \max(E) \text{ and } \min(W) \text{ to } \min(S) \\ \text{and} \\ 2L\text{-path from } \min(N) \text{ to } \max(S) \end{cases}$$

Proof.

(\Leftarrow) Suppose that P satisfies only the first geometry, i.e., there exist L -paths from $\max(N)$ to $\max(E)$ and from $\max(W)$ to $\max(S)$. From the first L -path one can deduce that there exists a $2L$ -path from $\min(N)$ to $\max(E)$. From the second L -path one can deduce that there exists a $2L$ -path from $\min(W)$ to $\max(S)$. Now by convexity, there exists an L -path between $\max(W)$ and $\min(N)$ hence, there exists a $2L$ -path from $\min(N)$ and $\max(S)$. Similarly, by convexity there exists an L -path between $\min(W)$ and $\max(N)$ hence, there exists a $2L$ -path from $\min(W)$ to $\max(E)$. To summarize, all four paths in Theorem 1 are in P and hence P is $2L$ -convex. Similar reasoning holds for the geometries (2), (3), and (4).

(\Rightarrow) P is $2L$ -convex polyomino then, there exist $2L$ -paths from $\min(W)$ to $\max(E)$, and from $\min(N)$ to $\max(S)$. Now suppose that the four minimal geometries in Figure 12 are not satisfied. Then we have the following possibilities.

CASE 1:

There exist L -paths from $\min(N)$ to $\max(E)$ and from $\max(W)$ to $\min(S)$. From the first L -path, one can deduce that there exists an L -path between $\min(N)$ and $\min(E)$. From the second L -path, one can see that there is no information between $\min(W)$ and $\max(S)$, hence P is not $2L$ -convex polyomino.

CASE 2:

There exist L -paths from $\min(W)$ to $\max(S)$ and from $\max(N)$ to $\min(E)$. From the first L -path, one can deduce that there is an L -path between $\min(W)$ and $\min(S)$. From the second L -path, one can see that there is no information between $\min(N)$ and $\max(E)$, hence P is not $2L$ -convex polyomino.

In conclusion, the four geometries are necessary to characterize a $2L$ -convex polyomino in the class $\mathfrak{S}^{0,0}$. \square

Corollary 2. *If P satisfies the conditions of Theorem 2, then P is in the class $\mathfrak{S}_{2L}^{0,0}$.*

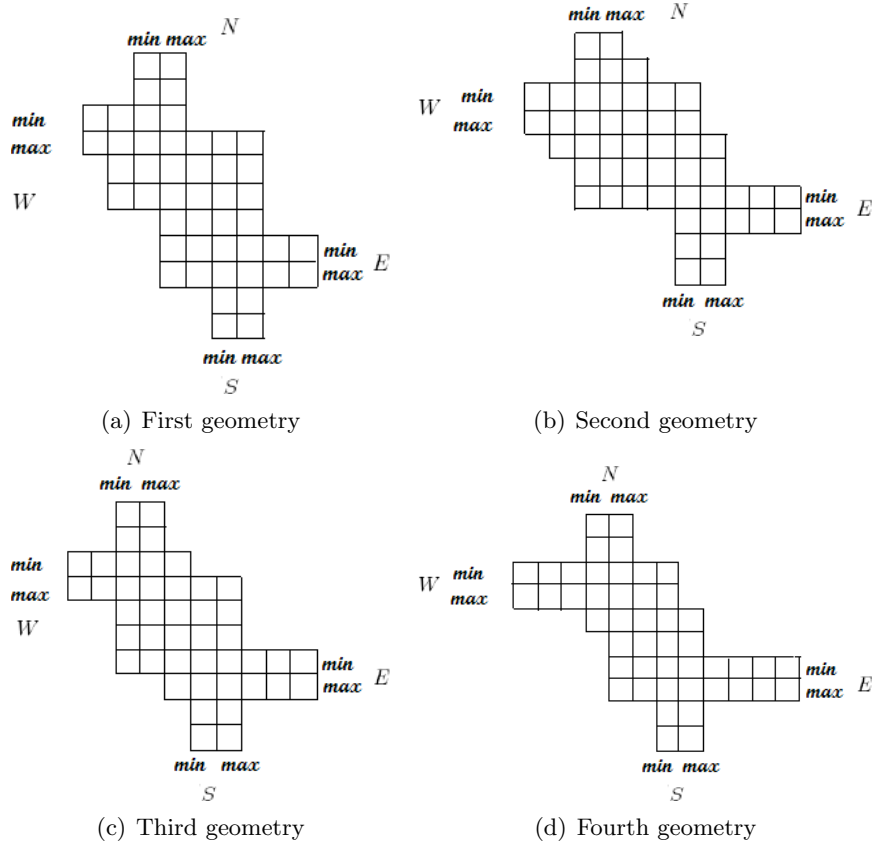

FIGURE 12. Geometries in the class $\mathfrak{S}_{2L}^{0,0}$.

4. POSSIBLE CONFIGURATIONS IN THE CLASS $\mathfrak{S}_{2L}^{0,0}$

In this section, we give the possible configurations of the polyominoes in the class $\mathfrak{S}_{2L}^{0,0}$. The goal is to study the switching components of $2L$ -convex

polyominoes and to give results of existence of switching in the different classes introduced in the previous section. The proofs of this section are rather technical and investigate all geometries and combinations of geometries. Thus we summarize all the results in a table at the end of this section.

Let $U(H, V)$ be the class of discrete sets having H and V as projections.

Definition 4. We define the 1-switching (or 1-cycle) as an operator whose successive application allows to move from an element of $U(H, V)$ to another element of $U(H, V)$. This basic operator, called elementary switching operator, or simply switching, transforms each simple configuration of cells of the kind depicted in Figure 13(a) into that one in (b) or vice versa.

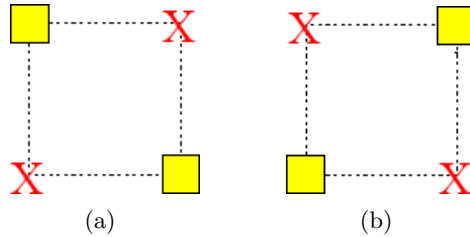

FIGURE 13. The two kinds of simple configurations. The switching operator transforms configuration of (a) into the one of (b) or vice versa.

In Figure 13, X represents the position of a point not belonging to the discrete set. The two configurations are called *switching components*.

Definition 5. We call 2-switching chain (2-cycles), the switching structures which are obtained by composing 2 elementary switchings such that the lower-rightmost point of the first one coincides with the upper-leftmost point of the second one.

We represent the 2-switching chain with the sequence of its 6 points, starting from the upper-leftmost one, then leading right till the next one, and then following the ideal straight lines connecting all the other couples of them. The switching in the Figure 14 is a 2-switching chain represented by the sequence of the six points $(1, 2), (1, 4), (6, 4), (6, 6), (4, 6), (4, 2)$. Notice that two consecutive points share a row or a column.

Proposition 5. Any $2L$ -convex polyominoes cannot contain any n -switching chain, with $n \geq 3$.

Proof. Let us proceed by contradiction assuming that there exists a $2L$ -convex polyominoes P containing a 3-switching chain, say $(i_1, j_1), (i_1, j_2), \dots, (i_4, j_4), (i_4, j_1)$. Let us further suppose that the cells (i_1, j_1) belongs to P , and so it is for the cell (i_3, j_3) . An easy check reveals that there does not exist in P a monotone path connecting (i_1, j_1) and (i_3, j_3) and having two

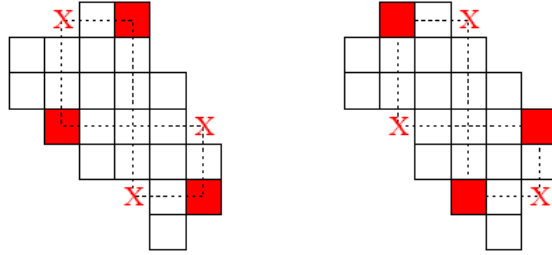

FIGURE 14. The two kinds of configurations for 2-cycles and two polyominoes belonging to the class $U(H, V)$, with $H = (2, 4, 5, 4, 4, 2, 1)$ and $V = (2, 3, 5, 5, 5, 2)$.

changes of direction at most, against the assumption. The same conclusion is obtained if we try to connect the cells (i_1, j_2) and (i_2, j_3) supposing that (i_1, j_1) does not belong to P . Obviously, the same result holds for any n -switching chain, with $n \geq 3$. \square

Proposition 6. *Let P be a $2L$ -convex polyomino in the class $\mathfrak{S}_{2L}^{0,0}$, and suppose that P satisfies the first geometry and does not satisfy the geometries 2, 3 and 4 (see Theorem 2); in other words, there is an L -path between $\max(N)$ and $\max(E)$, and an L -path between $\max(W)$ and $\max(S)$. Then P does not have the configuration*

$$\begin{array}{ccc} 0 & 1 & \\ 1 & 1 & 0 \\ & 0 & 1 \end{array}$$

Proof. Let us proceed by contradiction assuming that the configuration

$$\begin{array}{ccc} 0 & 1 & \\ 1 & 1 & 0 \\ & 0 & 1 \end{array}$$

exists. Since $\text{card}(ES) = 0$, then the position of the lower right 1 is either on $\max(S)$ or on $\max(E)$. Suppose that the lower right 1 is on $\max(S)$, then the upper right 0 is in the column $\max(S)$. If the upper right 0 is in the row $\max(W)$, then one can deduce that the L -path between $\max(W)$ and $\max(S)$ is violated, hence the contradiction.

The upper right 0 can not be in a row between $\max(W)$ and $\min(W)$ because of the definition of 2-cycles. If the upper right 0 is in the row $\min(W)$, then an L -path between $\min(W)$ and $\min(S)$ appears, in contradiction with the fact that P satisfies only the first geometry.

Same arguments when the lower right 1 is on $\max(E)$. \square

Proposition 7. *Let P be a $2L$ -convex polyomino in the class $\mathfrak{S}_{2L}^{0,0}$, and suppose that P satisfies the second geometry and does not satisfy the geometries*

1, 3 and 4 (see Theorem 2), i.e. there is an L -path between $\min(N)$ and $\min(E)$, and an L -path between $\min(W)$ and $\min(S)$, then P does not have the configuration

$$\begin{array}{ccc} 1 & 0 & \\ 0 & 1 & 1 \\ & 1 & 0 \end{array}$$

Proof. As in above, we proceed by contradiction assuming that the other configuration exists. \square

Corollary 3. *If P is a convex polyomino in the class γ or γ' , then P does not contain any configuration of the 2-cycles.*

Proof. It is an immediate checking from the definition of the 2-cycles and the positions of the feet. \square

4.1. **2-Cycles in the class $\mathfrak{S}_{2L}^{0,0}$.** In this paragraph, we give the conditions to obtain 2-cycles in the class $\mathfrak{S}_{2L}^{0,0}$.

Proposition 8. *Let P be a $2L$ -convex polyomino in the class $\mathfrak{S}_{2L}^{0,0}$ such that, P satisfies the third geometry and does not satisfy the geometries 1, 2 and 4. If P has 2-cycles in the class $\mathfrak{S}_{2L}^{0,0}$, then P' which is the image of P by the 2-cycles is in the class $\mathfrak{S}_{2L}^{0,0}$ and we have the two following cases:*

(1) *If the configuration*

$$\begin{array}{ccc} 1 & 0 & \\ 0 & 1 & 1 \\ & 1 & 0 \end{array}$$

exists for P , then $\min(N)$ is at the position $(1, 2)$ and $\max(E)$ is at the position $(m - 1, n)$. Moreover P' satisfies the second geometry.

(2) *If the configuration*

$$\begin{array}{ccc} 0 & 1 & \\ 1 & 1 & 0 \\ & 0 & 1 \end{array}$$

exists for P , then $\min(W)$ is at the position $(2, 1)$ and $\max(S)$ is at the position $(m, n - 1)$. Moreover P' satisfies the first geometry.

Proof. Suppose that P has the configuration

$$\begin{array}{ccc} 1 & 0 & \\ 0 & 1 & 1 \\ & 1 & 0 \end{array}$$

The upper left 1 of the configuration is on $\min(W)$ and not on $\min(N)$. In fact if the upper left 1 is on $\min(N)$, and since we have an L -path between $\min(N)$ and $\min(E)$, then the $0 \ 1 \ 1$ of the configuration can not be on the row $\min(E)$, or in a row in between $\max(W)$ and $\min(E)$, in contradiction with the definition of the 2-switching. Now we have that P' is $2L$ -convex in the class $\mathfrak{S}_{2L}^{0,0}$, thus $\text{card}(WN) = 0$ and $\text{card}(ES) = 0$, one

can deduce that $\min(N)$ is at the position $(1, 2)$, $\max(E)$ is at the position $(m - 1, n)$, and $\max(S)$ is not at the position $(m, n - 1)$. In fact if $\max(S)$ is at the position $(m, n - 1)$ then one can see that $\max(S) = \max(E)$ in P' , and thus P' is not in the class $\mathfrak{S}_{2L}^{0,0}$ (see section: Directed sets). Now, P' has the configuration

$$\begin{matrix} 0 & 1 \\ 1 & 1 & 0 \\ & 0 & 1 \end{matrix}$$

in the class $\mathfrak{S}_{2L}^{0,0}$, then the lower right 1 of the configuration is on $\max(S)$, the L -path between $\min(N)$ and $\min(E)$ still exists and P' is $2L$ -convex, one can deduce that there exists a L -path between $\min(W)$ and $\min(E)$. Hence P satisfies the second geometry (see Figure 15).
 Similar reasoning holds if P has the other configuration. □

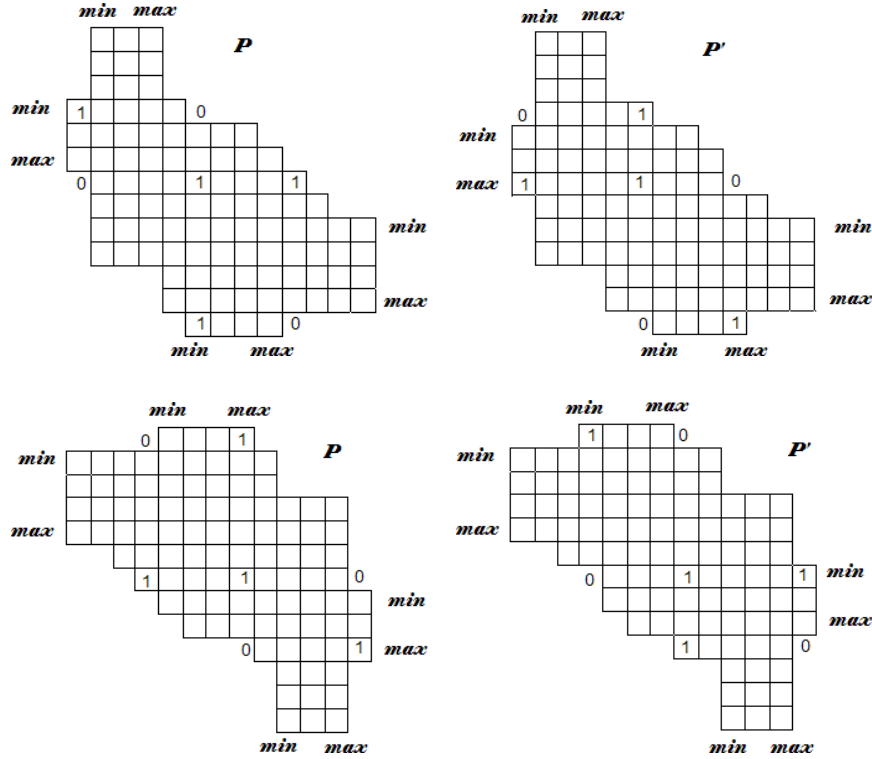

FIGURE 15. Third geometry and the 2-cycles in the class $\mathfrak{S}_{2L}^{0,0}$.

Proposition 9. *Let P be a $2L$ -convex polyomino in the class $\mathfrak{S}_{2L}^{0,0}$ such that, P satisfies the fourth geometry and does not satisfy the geometries 1, 2 and 3 (see Theorem 2). If P has 2-cycles in the class $\mathfrak{S}_{2L}^{0,0}$, then P' is in the class $\mathfrak{S}_{2L}^{0,0}$ and we have the two following cases:*

(1) *If the configuration*

$$\begin{array}{ccc} 1 & 0 & \\ 0 & 1 & 1 \\ & 1 & 0 \end{array}$$

exists for P , then $\min(W)$ is at the position $(2, 1)$ and $\max(S)$ is at the position $(m, n - 1)$. Moreover P' satisfies the second geometry.

(2) *If the configuration*

$$\begin{array}{ccc} 0 & 1 & \\ 1 & 1 & 0 \\ & 0 & 1 \end{array}$$

exists for P , then $\min(N)$ is at the position $(1, 2)$ and $\max(E)$, i.e. the $m - 1$ row and the n column, and $\min(N)$ is not at the position $(1, 2)$. Moreover P' satisfies the first geometry.

Proof. Similar to the above proof. □

4.2. Conditions of the two kinds of the simple configurations and relation with the 2-cycles in the class $\mathfrak{S}_{2L}^{0,0}$.

Proposition 10. *Let P be a $2L$ -convex polyomino in the class $\mathfrak{S}_{2L}^{0,0}$, and suppose that P has the two kinds of the simple configurations, then P verifies all four geometries and if P has the simple configuration*

$$\begin{array}{cc} 1 & 0 \\ 0 & 1 \end{array}$$

then $\min(N) = \max(N)$ and $\min(S) = \max(S)$, or $\min(W) = \max(W)$ and $\min(E) = \max(E)$.

Proof. Suppose that P has the simple configuration

$$\begin{array}{cc} 0 & 1 \\ 1 & 0 \end{array}$$

By construction, the upper left 0 is situated at the position where $I_{\min} = \min(W) - 1$ and $J_{\min} = \min(N) - 1$. The lower right 0 is situated at the position where $I_{\max} = \max(E) + 1$ and $J_{\max} = \max(S) + 1$. Thus this simple configuration gives the following rectangle:

$$\begin{array}{cccccccc}
 0 & 1 & \cdot & \cdot & \cdot & \cdot & 1 & 1 & \overline{\quad} & I_{\min} = \min(W) - 1 \\
 1 & 1 & \cdot & \cdot & \cdot & \cdot & 1 & 1 & & \\
 \cdot & \cdot & \cdot & \cdot & \cdot & \cdot & \cdot & \cdot & & \\
 \cdot & \cdot & \cdot & \cdot & \cdot & \cdot & \cdot & \cdot & & \\
 \cdot & \cdot & \cdot & \cdot & \cdot & \cdot & \cdot & \cdot & & \\
 1 & 1 & \cdot & \cdot & \cdot & \cdot & 1 & 1 & & \\
 1 & 1 & \cdot & \cdot & \cdot & \cdot & 1 & 0 & \overline{\quad} & I_{\max} = \max(E) + 1 \\
 \parallel & & & & & & \parallel & & & \\
 J_{\min} = \min(N) - 1 & & & & & & J_{\max} = \max(S) + 1 & & &
 \end{array}$$

One can deduce the following cases

$$\begin{array}{l}
 J_{\min} < \min(N) \leq \max(N) < J_{\max}; \\
 J_{\min} < \min(S) \leq \max(S) < J_{\max}; \\
 I_{\min} < \min(W) \leq \max(W) < I_{\max}; \text{ and} \\
 I_{\min} < \min(E) \leq \max(E) < I_{\max}.
 \end{array}$$

Thus there exists an L -path between $\min(N)$ and $\max(E)$, an L -path between $\min(W)$ and $\max(S)$, hence we have the four geometries. Now suppose that the simple configuration

$$\begin{array}{cc}
 1 & 0 \\
 0 & 1
 \end{array}$$

exists and that the upper left 1 is on $\min(W)$. Since $\text{card}(ES) = 0$, then the lower right 1 is on $\max(E)$. Suppose that $\min(W) \neq \max(W)$, then there exists a cell between $\min(W)$ and $\max(W)$ such that to obtain the configuration, P must be h -centered. Hence the contradiction.

If the upper left 1 is on $\min(N)$, then the lower right 1 is on $\max(S)$. Suppose that $\min(N) \neq \max(N)$, then there exists a cell between them such that to obtain the configuration, P has to be v -centered. Hence the contradiction (see Figure 16). \square

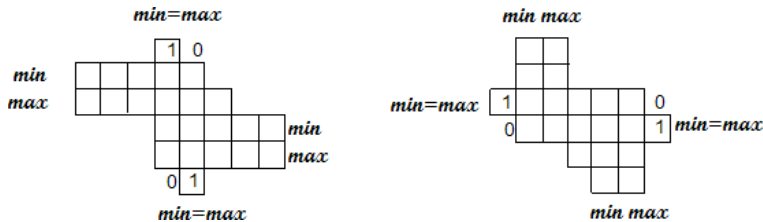

FIGURE 16. A simple configuration in the class $\mathfrak{S}_{2L}^{0,0}$.

Proposition 11. *Let P be a $2L$ -convex polyomino in the class $\mathfrak{S}_{2L}^{0,0}$, and suppose that P has the two kinds of the simple configurations, then the two configurations below do not exist and so P has no 2-cycles*

$$\begin{array}{ccc} 0 & 1 & \\ 1 & 1 & 0 \end{array} \quad \text{and} \quad \begin{array}{ccc} & & 1 & 0 \\ 0 & 1 & 1 & \\ & & & 1 & 0 \end{array}$$

Proof. Suppose that P has the simple configuration

$$\begin{array}{cc} 0 & 1 \\ 1 & 0 \end{array}$$

and $\min(W) \neq \max(W)$ and $\min(N) \neq \max(N)$ so that the other simple configuration does not exist. Let us proceed by contradiction assuming that the two configurations exist. First we begin with the configuration

$$\begin{array}{ccc} 0 & 1 & \\ 1 & 1 & 0 \\ & 0 & 1 \end{array}$$

The lower right 1 is on $\max(S)$ or $\max(E)$. If the lower right 1 is on $\max(S)$, then the upper right 0 is at the position where $i < I_{\min}$ and $j = \max(S)$, and the upper left 1 in the middle of the configuration is at the position where $i < I_{\min}$ and $j \leq J_{\min}$, thus $\text{card}(WN) \geq 1$, hence the contradiction. Now suppose that the lower right 1 is on $\max(E)$, then the position of the upper left 1 in the middle of the configuration is in $(1, \min(W))$, in contradiction with the fact that P is not h -centered.

Same arguments hold for the other simple configuration. \square

4.3. Table of intersections and uniqueness of the class $\mathfrak{S}_{2L}^{0,0}$. In this paragraph we give the table of intersections of the four geometries and the uniqueness of the class $\mathfrak{S}_{2L}^{0,0}$.

Proposition 12. *Let P be a $2L$ -convex polyomino in the class $\mathfrak{S}_{2L}^{0,0}$, then we have the following facts*

- (1) *if P satisfies the first and the second geometries, then it satisfies all four geometries and then P does not contain any configuration of the 2-switching chain.*
- (2) *if P satisfies the third and the fourth geometries, then it satisfies all four geometries and then P does not contain any configuration of the 2-switching chain.*
- (3) *if P satisfies the first and the fourth or the first and the third geometries, then P does not have the configuration*

$$\begin{array}{ccc} 0 & 1 & \\ 1 & 1 & 0 \\ & 0 & 1 \end{array}$$

- (4) if P satisfies the second and the fourth or the second and the third geometries, then P does not have the configuration

$$\begin{array}{ccc} 1 & 0 & \\ 0 & 1 & 1 \\ & 1 & 0 \end{array}$$

Proof. See Propositions 6 and 7. \square

Corollary 4. *Let P be a $2L$ -convex polyomino in the class $\mathfrak{S}_{2L}^{0,0}$, if P contains a simple configuration then the polyomino P' is always $2L$ -convex, and P is unique in the class $\mathfrak{S}_{2L}^{0,0}$.*

Proof. Let us begin with the simple configuration

$$\begin{array}{cc} 1 & 0 \\ 0 & 1 \end{array}$$

and suppose that $\min(W) = \max(W)$ and $\min(E) = \max(E)$, thus the upper left 1 of the configuration is on $\min(W) = \max(W)$ and the lower right 1 is on $\min(E) = \max(E)$. By applying the configuration, one can deduce that $\max(N) < \min(S)$ and $\min(W) = \max(W) > \min(E) = \max(E)$, and then P' belongs to the class γ and P is unique in the class $\mathfrak{S}_{2L}^{0,0}$. By convexity of the class of P' , it is a $2L$ -convex polyomino.

Now suppose that $\min(N) = \max(N)$ and $\min(S) = \max(S)$, thus the upper left 1 is on $\min(N) = \max(N)$ and the lower right 1 is on $\min(S) = \max(S)$. By applying the configuration, one can deduce that $\max(W) < \min(E)$ and $\min(N) = \max(N) > \min(S) = \max(S)$, then P' belongs to the class γ' and P is unique in the class $\mathfrak{S}_{2L}^{0,0}$. By convexity of the class of P' , it is a $2L$ -convex polyomino.

If we have $\min(N) = \max(N)$ and $\min(S) = \max(S)$, $\min(W) = \max(W)$ and $\min(E) = \max(E)$, then P' has $\min(N) = \max(N) > \min(S) = \max(S)$, $\min(E) = \max(E) > \min(W) = \max(W)$ and P is unique in the class $\mathfrak{S}_{2L}^{0,0}$. If $\text{card}(NE) = 0$ and $\text{card}(WS) = 0$, then P' belongs to the class $\mathfrak{S}_{2L}^{0,0}$ and by the transformation S_H (see Figure 7), one can deduce that P' is $2L$ -convex. If $\text{card}(NE) \neq 0$ and $\text{card}(WS) \neq 0$, it is also $2L$ -convex (see the form of the configuration).

If we have the other simple configuration

$$\begin{array}{cc} 0 & 1 \\ 1 & 0 \end{array}$$

then by Proposition 10 and the form of the configuration, P' has $\text{card}(WN) = 1$ and $\text{card}(ES) = 1$, thus P is unique in the class $\mathfrak{S}_{2L}^{0,0}$ (see Figure 17). This simple configuration does not change the position of the feet and since we

have the following rectangle in P'

1	1	·	·	·	1	0
1	1	·	·	·	1	1
1	1	·	·	·	1	1
·	·	·	·	·	·	·
·	·	·	·	·	·	·
·	·	·	·	·	·	·
1	1	·	·	·	1	1
0	1	·	·	·	1	1

So one can deduce that P' is $2L$ -convex. □

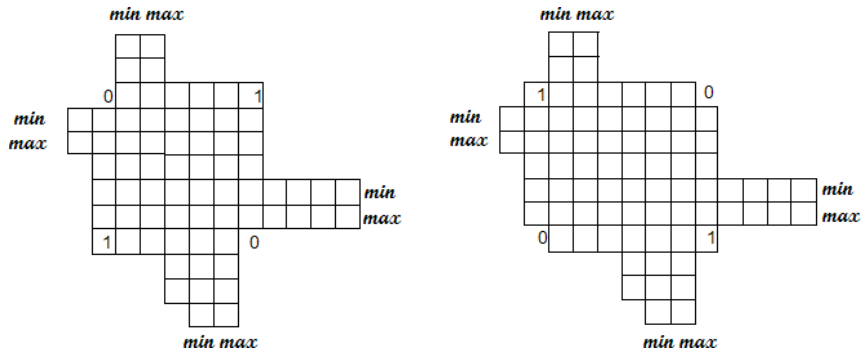

FIGURE 17. The $2L$ -convex P in the left and P' in the right.

Corollary 5. *Let P be a $2L$ -convex polyomino in the class $\mathfrak{S}_{2L}^{0,0}$, if P does not have the conditions of the 2-cycles and if the four geometries are not satisfied, then the polyomino P is unique in the class $\mathfrak{S}_{2L}^{0,0}$.*

Proof. See Propositions 8, 9, and 10. □

We put the previous results of the class $\mathfrak{S}_{2L}^{0,0}$ in a table (see Table 1) in order to summarize them.

Remark 1.

- (1) $1 \cap 2 = 3 \cap 4 = 1 \cap 2 \cap 3 \cap 4$.
- (2) *The empty cells in the table mean that the unicity in the class $\mathfrak{S}_{2L}^{0,0}$ with the geometries (1), (2), (3), and (4) is not guaranteed.*
- (3) *By “simple configuration” we mean the two configurations*

0	1		and	1	0
1	0			0	1

Geometry	Simple configuration	1-cycle	Configuration	2-cycles	Unicity $\mathfrak{S}_{2L}^{0,0}$
1	Impossible	Impossible	Possible Proposition 6	Possible Proposition 8,9	
2	Impossible	Impossible	Possible Proposition 7	Possible Proposition 8,9	
3	Impossible	Impossible	Possible Proposition 8	Possible Proposition 8	
4	Impossible	Impossible	Possible Proposition 9	Possible Proposition 9	
$1 \cap 3$ $1 \cap 4$ $2 \cap 3$ $2 \cap 4$	Impossible	Impossible	Possible Proposition 12	Impossible Proposition 12	Yes Corollary 5
$1 \cap 2 \cap 3 \cap 4$	Possible Proposition 10	Impossible Proposition 10	Impossible Proposition 11	Impossible Proposition 11	Yes Corollary 4

TABLE 1. Summary of the results of the class $\mathfrak{S}_{2L}^{0,0}$

And by “configuration” we mean the two configurations

$$\begin{array}{ccc} 0 & 1 & \\ 1 & 1 & 0 \\ 0 & 1 & \end{array} \quad \text{and} \quad \begin{array}{ccc} 1 & 0 & \\ 0 & 1 & 1 \\ 1 & 0 & \end{array}$$

Remark 2. Note that similar results can be obtained in the class $\mathfrak{S}^{0,0}$, on the basis of the properties of the transformation S_H (see Figure 7) with the following changes:

$$\begin{array}{ccc} 1 & 0 & \\ 0 & 1 & 1 \\ 1 & 0 & \end{array} \longrightarrow \begin{array}{ccc} 1 & 0 & \\ 0 & 1 & 1 \\ 1 & 0 & \end{array},$$

$$\begin{array}{ccc} 0 & 1 & \\ 1 & 1 & 0 \\ 0 & 1 & \end{array} \longrightarrow \begin{array}{ccc} 1 & 1 & 0 \\ 0 & 1 & \\ 0 & 1 & \end{array},$$

$$\begin{array}{ccc} 1 & 0 & \\ 0 & 1 & \end{array} \longrightarrow \begin{array}{ccc} 0 & 1 & \\ 1 & 0 & \end{array}.$$

5. DIRECTED SETS

There are four kinds of directed sets. The first one is denoted by \wp where, the N -foot and the W -foot intersect at the position $(\min(W), \min(N))$, i.e. they share the cell $(1,1)$ in the polyomino P . The second kind is denoted by η where, the E -foot and the S -foot intersect at the position $(\max(E), \max(S))$, i.e. they share the cell (m,n) in the polyomino P . By the horizontal transformation S_H (see Figure 7), one can see that there are two other directed sets denoted by \wp' and η' . In this section we characterize the structure of the classes \wp_{2L}^0 and η_{2L}^0 . Their reconstruction would be the goal of a future work. It is important to note that the more general class of HV -convex directed sets iniqueness is well-known from [10].

Let us define the following classes

$$\begin{aligned} \wp &= \{P \in \mathcal{C} \mid \min(N) = \min(W)\}, \\ \wp^0 &= \{P \in \mathcal{C} \mid \min(N) = \min(W) \text{ and } \text{card}(SE) = 0\}, \\ \eta &= \{P \in \mathcal{C} \mid \max(S) = \max(E)\}, \\ \eta^0 &= \{P \in \mathcal{C} \mid \max(S) = \max(E) \text{ and } \text{card}(WN) = 0\}; \end{aligned}$$

and for a $2L$ -convex polyomino P ,

$$\begin{aligned} \wp_{2L} &= \{P \mid \min(N) = \min(W)\}, \\ \wp_{2L}^0 &= \{P \mid \min(N) = \min(W) \text{ and } \text{card}(SE) = 0\}, \\ \eta_{2L} &= \{P \mid \max(S) = \max(E)\}, \\ \eta_{2L}^0 &= \{P \mid \max(S) = \max(E) \text{ and } \text{card}(WN) = 0\}. \end{aligned}$$

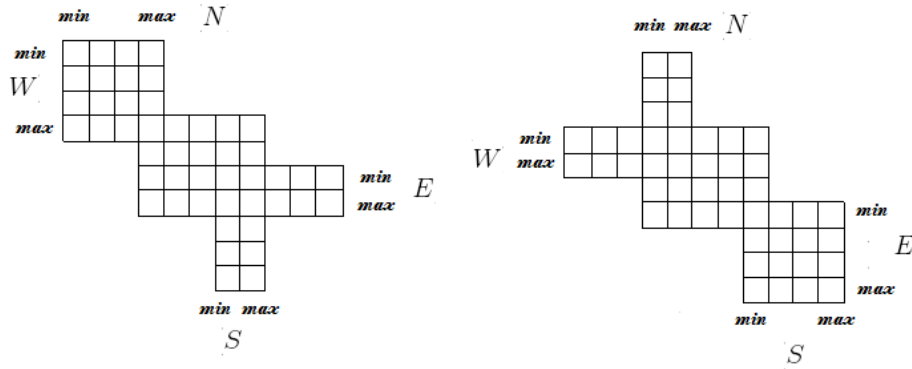

FIGURE 18. 2L-convex polyominoes in the classes φ_{2L}^0 (left) and η_{2L}^0 (right).

5.1. **Properties of the classes φ^0 and η^0 .** Let P be a convex polyomino in the class φ^0 . Then the following characterizations hold.

Theorem 3. *Let P be a convex polyomino in the class φ^0 , P is 2L-convex if and only if there exists a 2L-path from*

- (1) $\min(N) = \min(W)$ to $\max(E)$,
- (2) $\min(N) = \min(W)$ to $\max(S)$.

Proof. See Theorem 1. □

Corollary 6. *If P satisfies the conditions of Theorem 3, then P is in the class φ_{2L}^0 .*

Theorem 4. *Let P be a convex polyomino in the class φ^0 , P is 2L-convex if and only if there exists an L-path from $\max(N)$ to $\max(E)$ and $\max(W)$ to $\max(S)$.*

Proof.

(\implies) We have an L-path between $\max(N)$ and $\max(E)$, then there exists a 2L-path from $\min(N)$ to $\max(E)$ and from $\min(W)$ to $\max(E)$ since $\min(W) = \min(N)$. Similarly, there exists a 2L-path from $\min(N)$ to $\max(S)$ and from $\min(W)$ to $\max(S)$ since we have an L-path between $\max(W)$ and $\max(S)$, using Theorem 5, we get that P is 2L-convex.

(\impliedby) Suppose that the L-path between $\max(N)$ and $\max(E)$ is not minimal, since P is 2L-convex, then we have the three following possibilities:

- (1) There exists an L-path between $\min(N)$ and $\min(E)$, one can deduce that P is h -centered.
- (2) There exists an L-path between $\min(N)$ and $\max(E)$, one can deduce that P is v -centered.
- (3) There exists an L-path between $\max(N)$ and $\min(E)$, then there is no information between $\min(N)$ and $\max(E)$.

Hence the contradiction. Similarly for the other minimal L . \square

Corollary 7. *If P satisfies the conditions of Theorem 4, then P is in the class \wp_{2L}^0 .*

Let P be a convex polyomino in the class η^0 . Then following characterizations hold

Theorem 5. *Let P be a convex polyomino in the class η^0 , P is $2L$ -convex if and only if there exists a $2L$ -path from*

- (1) $\min(N)$ to $\max(E) = \max(S)$,
- (2) $\min(W)$ to $\max(E) = \max(S)$.

Corollary 8. *If P satisfies the conditions of Theorem 5, then P is in the class η_{2L}^0 .*

Theorem 6. *Let P be a convex polyomino in the class η^0 , P is $2L$ -convex if and only if there exists an L -path from $\min(N)$ to $\min(E)$ and $\min(W)$ to $\min(S)$.*

Corollary 9. *If P satisfies the conditions of Theorem 6, then P is in the class η_{2L}^0 .*

Theorem 7. *If $\min(N) = \min(W)$ and $\max(S) = \max(E)$, then P is $2L$ -convex if and only if P is h -centered or v -centered.*

Proof. Suppose that P is not h -centered or v -centered, one can deduce that there is no path from $\min(N) = \min(W)$ to $\max(S) = \max(E)$ that has at most two changes of direction, hence the contradiction. \square

The transformation S_H allows us to define the following classes

$$\begin{aligned}\wp' &= \{P \in \mathcal{C} \mid \min(S) = \max(W)\}, \\ \wp'^0 &= \{P \in \mathcal{C} \mid \min(S) = \max(W) \text{ and } \text{card}(NE) = 0\}, \\ \eta' &= \{P \in \mathcal{C} \mid \max(N) = \min(E)\}, \\ \eta'^0 &= \{P \in \mathcal{C} \mid \max(S) = \max(E) \text{ and } \text{card}(WS) = 0\};\end{aligned}$$

and for a $2L$ -convex polyomino P ,

$$\begin{aligned}\wp'_{2L} &= \{P \mid \min(S) = \max(W)\}, \\ \wp'^0_{2L} &= \{P \mid \min(S) = \max(W) \text{ and } \text{card}(NE) = 0\}, \\ \eta'_{2L} &= \{P \mid \max(N) = \min(E)\}, \\ \eta'^0_{2L} &= \{P \mid \max(S) = \max(E) \text{ and } \text{card}(WS) = 0\}.\end{aligned}$$

Note that the transformation S_H maps \wp to \wp' and η to η' . To avoid repetitions, one can see that the same characterizations hold for these classes

with the following changes.

$$\begin{array}{ccccccc} 1 & 0 & & & 1 & 0 & \\ 0 & 1 & 1 & \longrightarrow & 0 & 1 & 1 \text{ ,} \\ & & 1 & 0 & & 1 & 0 \\ \\ 0 & 1 & & & 0 & 1 & \\ 1 & 1 & 0 & \longrightarrow & 1 & 1 & 0 \text{ .} \\ & & 0 & 1 & & 0 & 1 \end{array}$$

Theorem 8. *If $\min(S) = \max(W)$ and $\max(N) = \min(E)$, then P is $2L$ -convex if and only if P is h -centered or v -centered.*

6. FINAL COMMENTS

This study is a theoretical step for the reconstruction of the sub-class $\mathfrak{S}_{2L}^{0,0}$. In the spirit of discrete tomography the design of a reconstruction algorithm for such polyominoes would be the subject of a future article. We are also able to develop the material for the whole $2L$ -convex class with the study of 16 geometries and a reconstruction algorithm for $2L$ -convex polyominoes in a future article.

REFERENCES

1. E. Barucci, A. Del Lungo, M. Nivat, and R. Pinzani, *Reconstructing convex polyominoes from horizontal and vertical projections*, Theor. Comput. Sci. **155** (1996), 321–347.
2. S. Brunetti and A. Daurat, *An algorithm reconstructing convex lattice sets*, Theor. Comput. Sci. **304** (2003), 35–57.
3. G. Castiglione, A. Frosini, A. Restivo, and S. Rinaldi, *A tomographical characterization of L -convex polyominoes*, Proceedings of 12th International Conference on Discrete Geometry for Computer Imagery (DGCI 2005, Poitiers, France, April 2005), Lecture Notes in Comput. Sci., vol. 3429, 2005, pp. 115–125.
4. G. Castiglione and A. Restivo, *Reconstruction of L -convex polyominoes*, Electron. Notes in Discrete Math. **12** (2003), 290–301.
5. G. Castiglione, A. Restivo, and R. Vaglica, *A reconstruction algorithm for L -convex polyominoes*, Theor. Comput. Sci. **356** (2006), 58–72.
6. M. Chrobak and C. Durr, *Reconstructing h v -convex polyominoes from orthogonal projections*, Inform. Process. Lett. **69** (1999), 283–289.
7. M.-P. Delest and G. Viennot, *Algebraic language and polyominoes enumerations*, Theor. Comput. Sci. **34** (1984), 169–206.
8. E. Duchi, S. Rinaldi, and G. Schaeffer, *The number of Z -convex polyominoes*, Advances in applied mathematics **40** (2008), no. 1, 54–72.
9. D. Klarner, *Some results concerning polyominoes*, Fib. Quart. **3** (1965), 9–20.
10. A. Del Lungo, *Polyominoes defined by two vectors*, Theor. Comput. Sci. **127** (1994), 187–198.

LABORATOIRE DE MATHÉMATIQUES, UNIVERSITÉ DE SAVOIE,
 CNRS UMR 5127, 73376 LE BOURGET DU LAC, FRANCE
E-mail address: khalil.tawbeh@univ-savoie.fr
E-mail address: laurent.vuillon@univ-savoie.fr